User's Manual

PMM L2-16B

ARTIFICIAL MAINS NETWORK

L

SERIAL NUMBER OF THE INSTRUMENT

You can find the Serial Number on the rear panel of the instrument.

Serial Number is in the form : 0000X00000.

The first four digits and the letter are the Serial Number prefix, the last five digits are the Serial Number suffix. The prefix is the same for identical instruments, it changes only when a configuration change is made to the instrument.

The suffix is different for each instrument.

NOTE:

© Names and Logo are registered trademarks of Narda Safety Test Solutions GmbH and L3 Communications Holdings, Inc. – Trade names are trademarks of the owners.

If the instrument is used in any other way than as described in this Users Manual, it may become unsafe



Before using this product, the related documentation must be read with great care and fully understood to familiarize with all the safety prescriptions.

To ensure the correct use and the maximum safety level, the User shall know all the instructions and recommendations contained in this document.

This products are a **Safety Class I** and **Installation Category II** instrument according to IEC classification and has been designed to meet the requirements of EN61010-1 (Safety Requirements for Electrical Equipment for Measurement, Control and Laboratory Use).









This product has a **Pollution Degree II** normally only non-conductive pollution occurs. Occasionally, however, a temporary conductivity caused by condensation must be expected.





The information contained in this document is subject to change without notice.

KEY TO THE ELECTRIC AND SAFETY SYMBOLS:

 You now own a high-quality instrument that will give you many years of reliable service. Nevertheless, even this product will eventually become obsolete. When that time comes, please remember that electronic equipment must be disposed of in accordance with local regulations. This product conforms to the WEEE Directive of the European Union (2002/96/EC) and belongs to Category 9 (Monitoring and Control Instruments). You can return the instrument to us free of charge for proper environment friendly disposal. You can obtain further information from your local Narda Sales Partner or by visiting our website at www.narda-sts.it.

	Warning, danger of electric shock		Earth
	Read carefully the Operating Manual and its instructions, pay attention to the safety symbols.		Unit Earth Connection
	Earth Protection		Equipotential

KEY TO THE SYMBOLS USED IN THIS DOCUMENT

	DANGER	The DANGER sign draws attention to a potential risk to a person's safety. All the precautions must be fully understood and applied before proceeding.
	WARNING	The WARNING sign draws attention to a potential risk of damage to the apparatus or loss of data. All the precautions must be fully understood and applied before proceeding.
	CAUTION	The CAUTION sign draws attention against unsafe practices for the apparatus functionality.
	NOTE:	The NOTE draw attention to important information.

Contents

Safety considerations and instructions.....	Page V
EC Declaration of Conformity	VI
1 General Information	Page
1.1 Documentation.....	1-1
1.2 Introduction.....	1-1
1.3 PMM L2-16B for “CURRENT INJECTION” test.....	1-2
1.4 Shipping components.....	1-3
1.5 Optional accessories.....	1-3
1.6 Environment.....	1-3
1.7 Return for service.....	1-3
1.8 Equipment cleaning.....	1-3
2 Main Specification	Page
2.1 Main specifications.....	2-1
3 L2-16B Equipment	Page
3.1 L2-16B Equipment.....	3-1
3.2 Metal lid.....	3-2
3.3 Handles.....	3-2
3.4 Metal base.....	3-2
3.5 Front and rear panel.....	3-3
3.6 Remote receiver control connector.....	3-4
3.7 LISN remote cable configuration for PMM 9010.....	3-5
3.8 LISN remote cable configuration for PMM 8010.....	3-6
4 Installation	Page
4.1 Introduction.....	4-1
4.2 Initial inspection.....	4-1
4.3 Packing unpacking.....	4-1
4.4 Preparation for use.....	4-1
4.5 Operating PMM L2-16B.....	4-2
4.6 Installation check list.....	4-2
5 Operating PMM L2-16B Network	Page
5.1 Test Set-Up Considerations.....	5-1
5.2 Network verification and maintenance.....	5-2

Figures

Figure		Page
1-1	CISPR 16 Equivalent circuit.....	1-2
1-2	PMM L2-16B Network.....	1-2
3-1	PMM L2-16B Network.....	3-1
3-2	Metal lid.....	3-2
3-3	Handles.....	3-2
3-4	Metal base.....	3-2
3-5	Front panel.....	3-3
3-6	Rear panel.....	3-3
3-7	“Remote control” connector (front view).....	3-4
3-8	LISN remote cable configuration for PMM 9010	3-5
3-9	LISN remote cable configuration for PMM 8010	3-6
5-1	Typical test set-up.....	5-1
5-2	Typical hand held equipment test set-up.....	5-2

Tables

Table		Page
2-1	Main Specification.....	2-1



SAFETY RECOMMENDATIONS AND INSTRUCTIONS

This product has been designed, produced and tested in Italy, and it left the factory in conditions fully complying with the current safety standards. To maintain it in safe conditions and ensure correct use, these general instructions must be fully understood and applied before the product is used.

- Over current protection is not provided in the LISN. The LISN must be connected to a power mains which has the properly rated mains protection installed.
- When the device must be connected permanently, first provide effective grounding;
- If the device must be connected to other equipment or accessories, make sure they are all safely grounded;
- In case of devices permanently connected to the power supply, and lacking any fuses or other devices of mains protection, the power line must be equipped with adequate protection commensurate to the consumption of all the devices connected to it;
- In case of connection of the device to the power mains, make sure before connection that the voltage selected on the voltage switch and the fuses are adequate for the voltage of the actual mains;
- Devices in Safety Class I, equipped with connection to the power mains by means of cord and plug, can only be plugged into a socket equipped with a ground wire;
- Any interruption or loosening of the ground wire or of a connecting power cable, inside or outside the device, will cause a potential risk for the safety of the personnel;
- Ground connections must not be interrupted intentionally;
- To prevent the possible danger of electrocution, do not remove any covers, panels or guards installed on the device, and refer only to NARDA Service Centers if maintenance should be necessary;
- To maintain adequate protection from fire hazards, replace fuses only with others of the same type and rating;
- Follow the safety regulations and any additional instructions in this manual to prevent accidents and damages.
- The probe cannot be handled in proximity of high voltage mains line.
- If the probe is to be connected to high voltage mains line a safety interlock equipment must be installed to ensure the mains line be switched off before any probe handling or connection
- The user must provide a safety protection cover with a low voltage interlock switch able to cut off mains voltage before probe handling or connection.

EC Declaration of Conformity

In accordance with the Decision 768/2008/EC
Compliant to the Directives: EMC 2014/30/EU, Low Voltage 2014/35/EU, RoHS 2011/65/EU
Also compliant to the ISO/IEC standards 17050-1 and 17050-2

The manufacturer,

*NARDA Safety Test Solutions s.r.l.
via Benessea 29/B
17035 Cisano sul Neva (SV) – ITALY*

based on the following harmonized European Standards, successfully applied:

Safety: EN 61010-1 (undated reference, applies to all editions)

EMC: EN 61326-1 (undated reference, applies to all editions)

declares, under its sole responsibility, that the product: **PMM L2-16B Artificial Mains Network** conforms with the essential requirements of the Low Voltage Directive 2014/35/EU, of the EMC Directive EMC 2014/30/EU and of the RoHS directive 2011/65/EU.

A handwritten signature in black ink, appearing to read "Egon Stocca".

Cisano sul Neva, 24/08/2016

Egon Stocca, General Manager

1 - General Information

1-1 Documentation

Enclosed with this manual are a service questionnaire to send back to NARDA in case of equipment service is needed, and an accessories check list to verify all accessories enclosed in the packaging.

1-2 Introduction to PMM L2-16B

The objective of EMI Conducted tests is to define the amplitude of current I_c and Voltage V_c emission from the Device Under Test (DUT) onto the power mains or to define the immunity of the DUT to the conducted interference.

The mains lines themselves do not allow for reliable EMI measurements since their impedance is subject to marked variations that generates different test results at different test sites.

PMM's Artificial Mains Network L2-16B is a LISN used for RFI measurements on AC single-phase, power supplied electric and electronic equipment, drawing up to 16 Amps, that is in the most frequently-encountered applications.

L2-16B is a two line V-network with an equivalent circuit of 50 ohm // (50ohm + 50 μ H), fully compliant with CISPR publ. 16, VDE 0876 and FCC part 15 regulation.

The PMM L2-16B is suited to perform measurements on conducted interference in the frequency range from 9 kHz to 30 MHz.

Designed according to criteria of cheaply and compactness it can be used together with PMM receivers for Conducted Interference like the PMM 9010 or any other RF receiver.

The main functions performed by the Artificial Mains Network are:

- terminate the DUT with a standardized impedance against reference ground;
- supply power to the DUT;
- insulate the test circuits against external interference coming, for example, from AC-voltage network;
- route the EMI (Electro Magnetic Interference) of the DUT to the receiver, in case of conducted emission measurement, and the EMI from the signal generator to the DUT, in case of susceptibility test (current injection).

Ferrite-cores coils are used in the low-pass filter. Saturation effects have been avoided designing a ferrite-core that is able to withstand a 50% increase of the I_{max} value without any saturation.

PMM L2-16B is provided with standard SCHUKO power socket 16 Amps. to connect test item, but other connector types are available on request.

**1-3 PMM L2-16B for
“CURRENT
INJECTION” test**

As described above, a LISN is primarily a probe to take out RF signals. Some particular EMC recommendations might require that Device Under Test shall be proven to conducted EMC immunity in the range 10 kHz - 30 MHz, by injecting on the supply lines certain RF interference and checking the DUT's response.

PMM L2-16B may be used also to this purpose by injecting a RF signal into the RF output connector on the front panel.

The following figure shows the CISPR equivalent circuit.

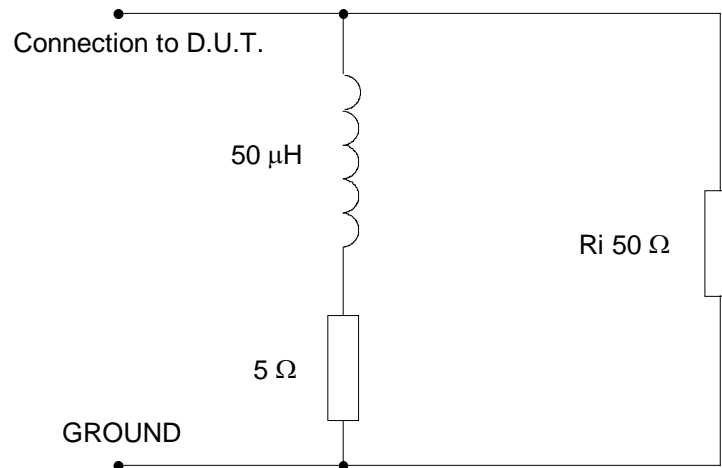

Ri = input impedance of the RFI

CISPR equivalent circuit

Fig. 1-1 CISPR equivalent circuit



Fig. 1-2 PMM L2-16B Network

1-4 Shipping components

PMM L2-16B Network is composed by the following parts:

- PMM L2-16B Network
- Operating Manual.
- Power Supply cable
- LISN Control Cable
- RF Cable
- Calibration Chart
- Return for repair form

1-5 Optional accessories

Options to order separately:

- LISN Service Kit (AC-BNC adapter for LISNs verification and calibration)

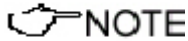

See “Annex D” 9010 User’s manual as example.

1-6 Environment

The operating environment is specified to be within the following limitations:

- Temperature -10° to +45° C
- Humidity < 90% relative

The instrument should be stored in a clean, dry environment

The storage and shipping environment is specified to be within the following limitations :

- Temperature -25° to + 75° C
- Humidity < 95% relative

1-7 Return for service

If the instrument should be returned to NARDA for service, please complete the service questionnaire enclosed with the Operating Manual and attach it to the instrument.

To minimize the repair time, be as specific as possible when describing the failure. If the failure only occurs under certain conditions, explain how to duplicate the failure.

If possible, reuse of the original packaging to ship the equipment is preferable.

In case other package should be used ensure to wrap the instrument in heavy paper or plastic.

Use a strong shipping container and use enough shock absorbing material around all sides of the equipment to provide a firm cushion and prevent movement in the container.

Seal the shipping container securely with shipment tape.

Mark the shipping container FRAGILE to encourage careful handling.

1-8 Equipment cleaning

Use a clean, dry non abrasive cloth for external cleaning of the equipment.

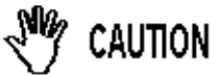

To clean the equipment do not use any solvent, thinner, turpentine, acid, acetone or similar matter to avoid damage to external plastic and surfaces.

This page has been left blank intentionally

2 - Main specifications

2-1 Main specifications Table 2-1 lists the PMM L2-16B Network performance specifications.

TABLE 2-1 Main specifications	
Frequency range:	9 kHz to 30 MHz
Continuous rated output current:	16 A
Max permissible operating voltages (L/N) (L/PE):	250Vac 350Vdc
Supply frequency range:	DC - 60 Hz
Equivalent circuit:	50 Ohm // (5 Ohm + 50 μH)
RF output:	BNC female
Test item:	SCHUKO connector
Rated temperature:	-10° to + 45° C
Storage temperature:	- 25° to + 75° C
Overall dimension mm (W x H x D):	230 x 105 x 285
Weight:	5,5 kg

This page has been left blank intentionally

3 – L2-16B Equipment

3.1 L2-16B Equipment

The PMM L2-16B equipment is composed by:

- Metal lid;
- Handles;
- Metal base;
- Front panel;
- Rear panel;



Fig. 3-1 PMM L1-150M

3.2 Metal lid

The inductor and the other components of the network are mounted on a metal frame which is then closed by metal lid. The lid is perforated in order to improve the heat dissipation.



Fig. 3-2 Metal lid

3.3 Handles

Using the handles, the PMM L2-16B can be placed in the right position.

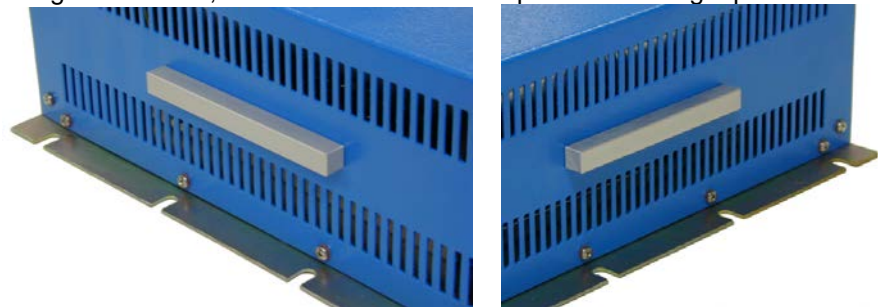

Fig. 3-3 Handles

3.4 Metal base

Position the PMM L2-16B where it will be installed, making sure it is leveled to ensure stability; the buttonhole on both side allows to fix the PMM L2-16B to the ground.



Fig. 3-4 Metal base

3.5 Front and rear panel In Figure 3-1, front panel of PMM L2-16B Network.

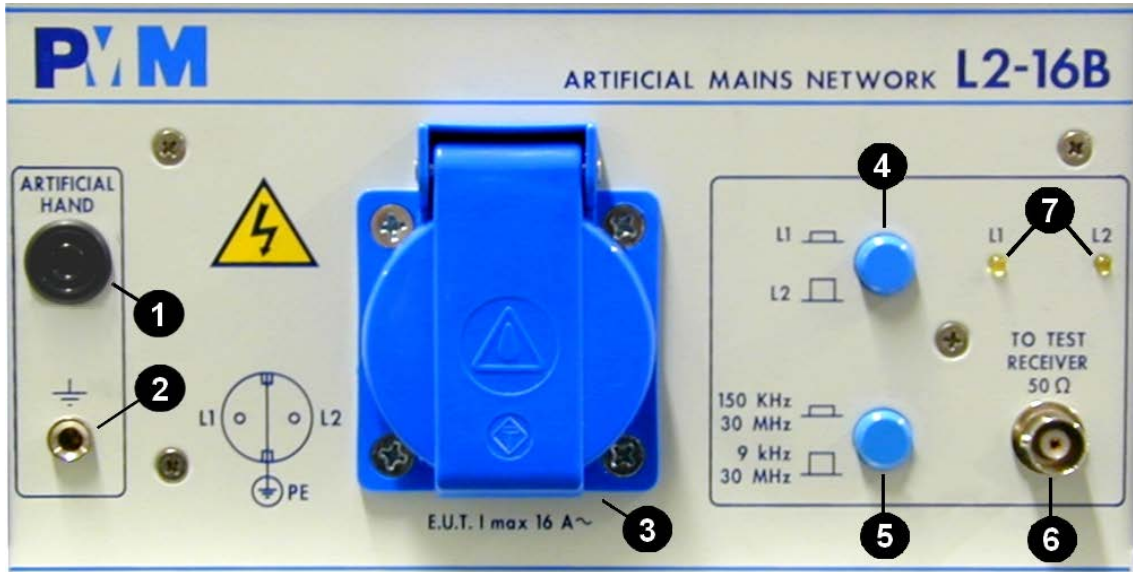

Fig. 3-5 Front Panel

Legend:

- 1- Artificial Hand
- 2- Ground contact for 4mm plug
- 3- Mains supply to DUT
- 4- Manual switch for phase under test (With PMM receivers remote control the switch is disabled and the switching is automatic)
- 5- Band Switch
- 6- RF output to EMI Signal Analyzer
- 7- Line under test indicating led

In Figure 3-2, rear panel of PMM L2-16B Network.

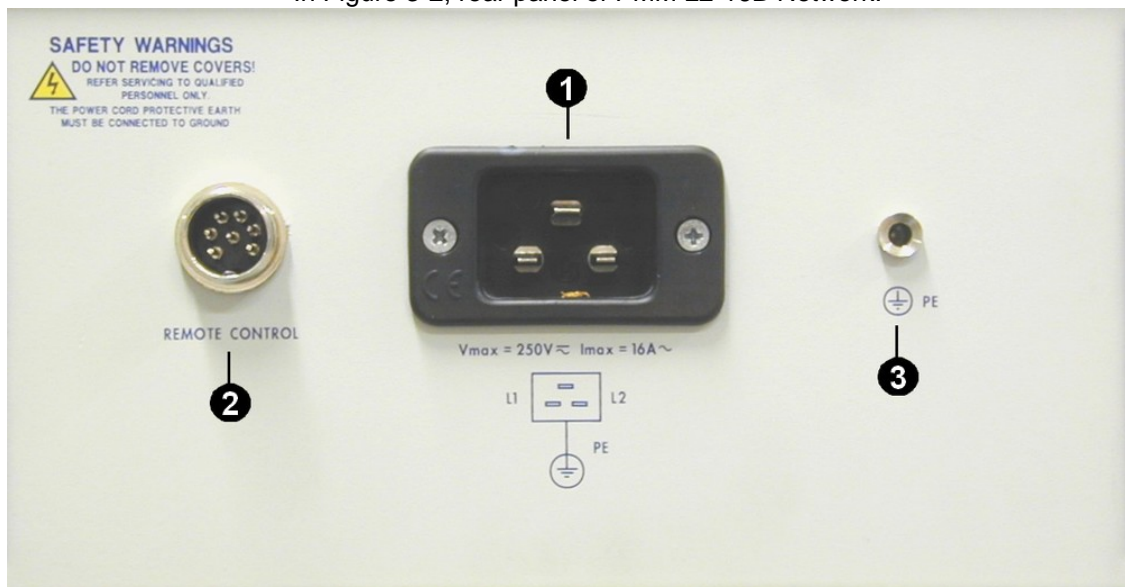

Fig. 3-6 Rear Panel

Legend:

- 1- Mains LISN supply
- 2- Remote control connector (for further information refer to § 3.6)
- 3- Protective earth connector for 4mm plug

3.6 Remote receiver control connector

The Remote receiver control connector is on the rear panel.

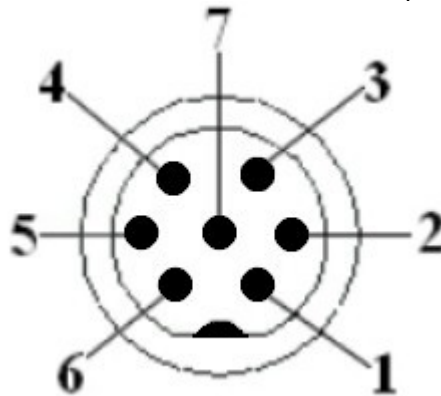

Fig. 3-7 "Remote Control" connector (Front view)

Legend:

- 1 = (GND)
- 2 = (+12V)
- 5 = (TTL)

TTL	LINE
-----	------

- | | |
|---|----|
| 0 | L1 |
| 1 | L2 |

Legend:

- 0 → GND
- 1 → +5V

3.7 LISN remote cable Configuration for PMM 9010

The following figure shows the LISN remote cable pin configuration. The cable is provided with the LISNs.

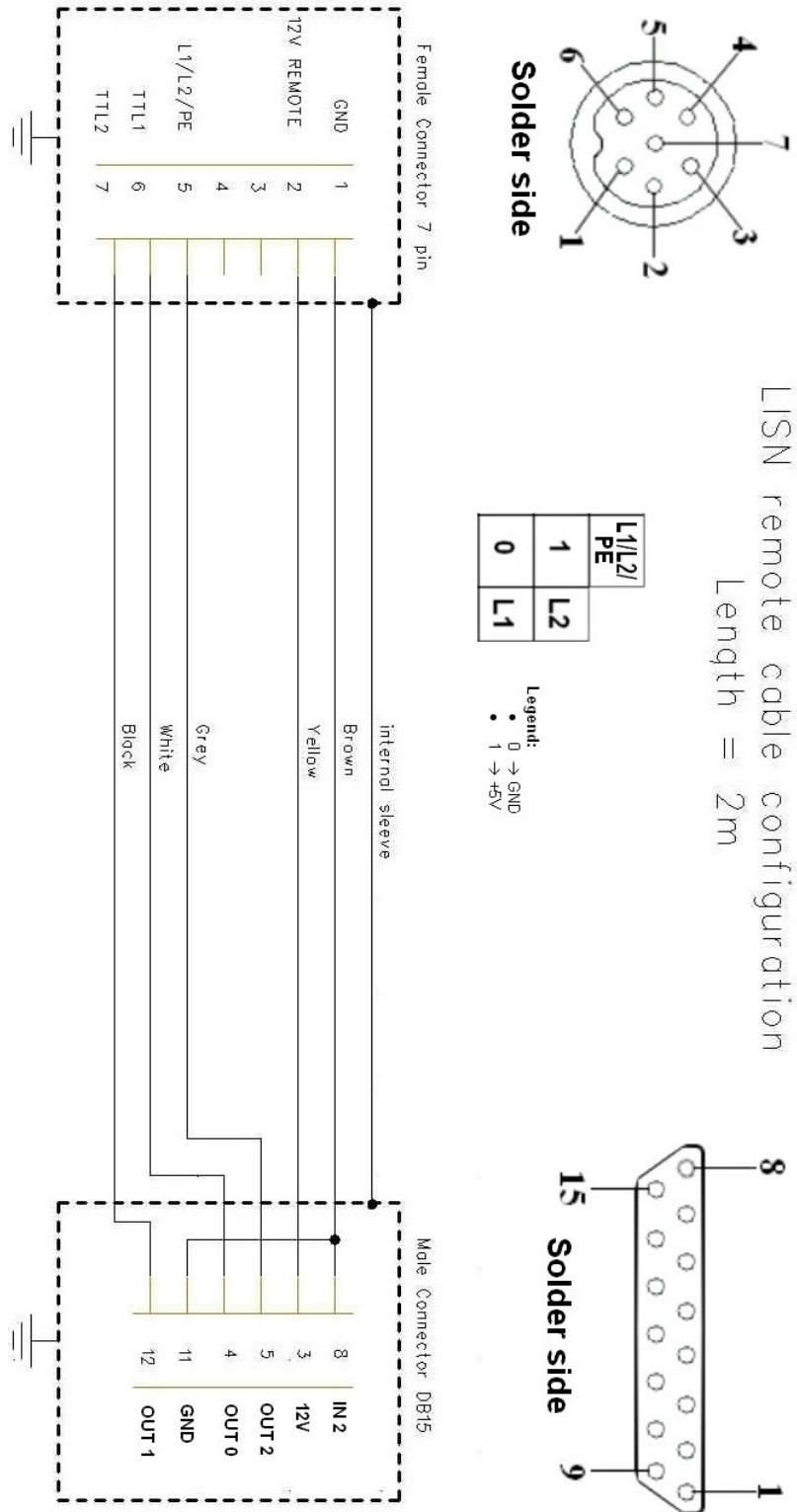

Fig. 3-8 LISN remote cable configuration for PMM 9010

3.8 LISN remote cable Configuration for PMM 8010

The following figure shows the LISN remote cable pin configuration. The cable can be requested to Narda or you can make it by yourself.

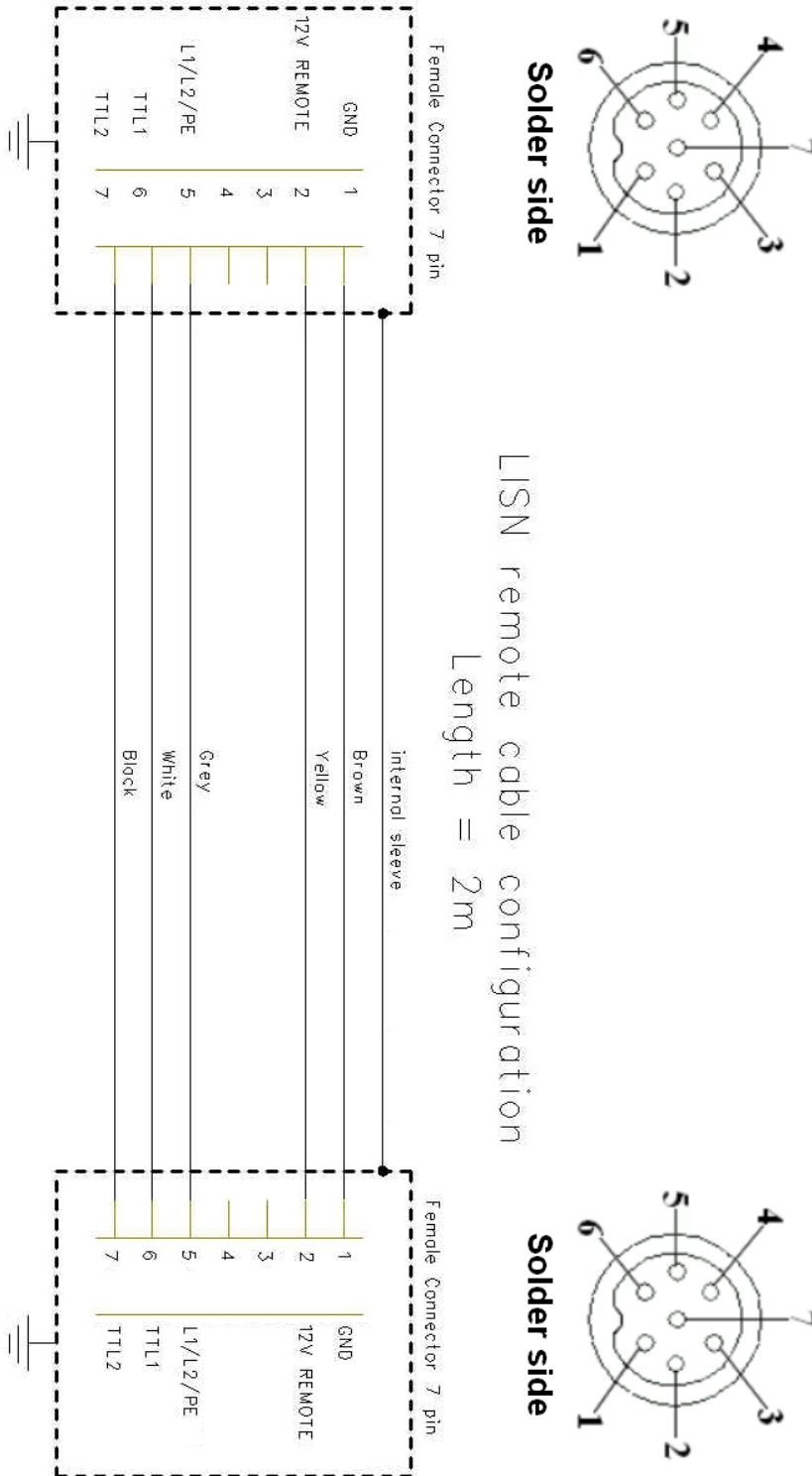

Fig. 3-9 LISN remote cable configuration for PMM 8010

4 - Installation

4-1 Introduction

This section provides the information needed to install the PMM L2-16B Network. Included is information pertinent to initial inspection, power requirements, interconnections, environment, instrument mounting, cleaning, storage and shipment.

4-2 Initial inspection



WARNING

To avoid hazardous electrical shock, do not turn on the instrument when there are signs of shipping damage to any portion of it.

4-3 Packing Unpacking

Inspect the shipping container for damage.

If the shipping container or cushion material is damaged, it should be kept until the contents of the shipment have been checked for completeness and the instrument has been checked mechanically and electrically.

Verify the accessories availability in the shipping container referring to the accessories check list enclosed with the Operating Manual.

Notify any damage to the carrier as well as the NARDA Representative.

4-4 Preparation for use

From the line conductor to the case of the unit there is a leakage current of approx. 80 mA when operating at 220 V 50 Hz.

The line conductor is connected to ground via a 2 μ F capacitor due to the measurement system to be applied.



WARNING

Over current protection is not provided in the LISN. The LISN must be connected to a power mains which has the properly rated mains protection installed.



WARNING

The leakage currents between the phases and the earth line generally exceed permitted limits for typical house environments due to internal capacitors; for this reason it is mandatory to use a current rated insulating transformer to supply the PMM L2-16B Network.



WARNING

PMM L2-16B Network, the insulating transformer and Equipment Under Test must be provided by an appropriate current rated contact breaker or fuses as closest as possible on the supply line and with a safety indication of equipment operated by.



WARNING

This is a Safety Class I equipment, it is provided with a protective earth terminal.

Before connecting this instrument, ensure that an uninterruptible safety earth ground is provided from the main power source to the product protective earth connection. If this instrument is to be connected to other equipment or accessories, prior to energizing either unit verify that a common ground exists between them.

Any interruption or loosening of the protective earth ground conductor, either inside or outside the unit or in an extension cable will cause a potential shock hazard that could result in personal injury. Verify the safety earth ground functionality before operation.

4-5 Operating PMM L2-16B

To operate PMM L2-16B connect the supply cable to the insulating transformer.

To avoid any damage caused by transient current pulses, connect the RF cable to the receiver only after the AC supply has been switched on.

The Equipment Under Test should be connected to the SCHUKO connector.

To select the phase line to be tested operate the phase switch L1/L2 on the front panel.

Using the PMM 9010 EMI Receiver the phase switching is automatic.

The button on the left of the BNC connector is used to insert an output 150kHz high pass filter. To press it to enable the high pass filter; when disable the output is full bandwidth.

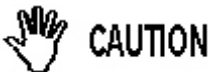

To avoid any damage caused by transient current pulses, disconnect the test Signal Analyzer input before switching AC supply on or off

4-6 Installation Check list Before operation ensure the following steps are taken:

- Check the line voltage to ensure the compatibility with the equipment requirements.
- Ensure that the to be provided fuse or breaker current rating is appropriate for the equipment setup.
- Protection earth line is connected to mains supply input on the rear panel.
- Ensure that cables and terminals used to connect PMM L2-16B Network to supply line and to Equipment Under Test are suitable for the setup current rating and proper safety insulation.
- Verify that 50 ohm coaxial line to the EMI Signal Analyzer input be disconnected before switch on or off the supply line.
- Prior to energizing either unit verify that a common ground connection exists between all equipment in the test setup and safety protection earth.

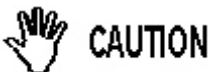

To allow correct equipment ventilation ensure that the vent grid on the rear equipment cover be free by any obstructing object.

5 - Operating PMM L2-16B Network

5-1 Test Set-Up Considerations

Measurement repeatability is the main concern of standards and regulations, that exactly define the test set-up for interference measurements.

The Artificial Mains Network L2-16B complies with CISPR publ.16 (part 2), VDE 0876 and the American FCC part 15 rules and regulations.

The test SET-UPS required for various standards are largely identical; a detailed description is given in VDE 0877 part 1. (par. 9.2 "Measurements using LISNs").

The DUT has to be positioned on a non-metallic or conductive table (height >80cm.), 40 cm. in front of a metallic grounded wall with dimensions of at least 2 m. x 2 m.

The table may also be used inside a screened room.

The distance of the DUT from any metallic part may affect the measured RFI voltage values; VDE 0877 exactly define the dimensions for the test configurations, by means of the following drawing:

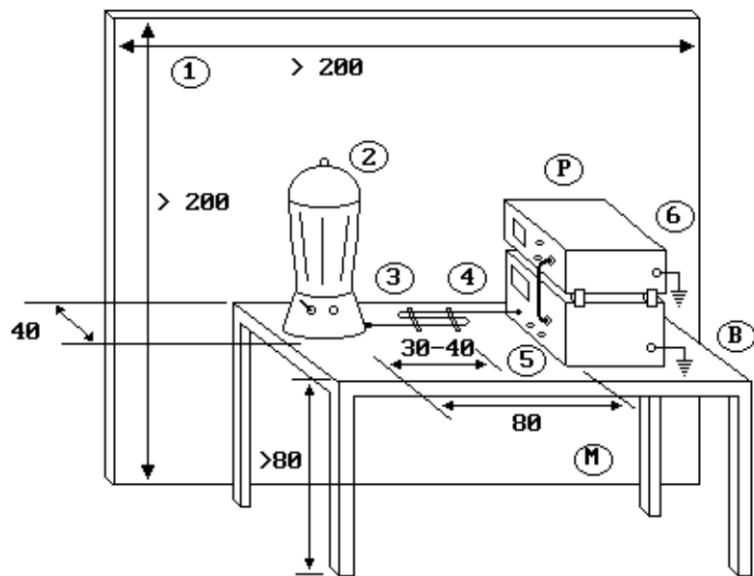

Fig. 5-1 Typical test set-up

The above figure describes the test configuration and the interconnection of a mains operated DUT, according to the above mentioned VDE specification, where:

1. Metallic grounded wall;
 2. Device Under Test (DUT);
 3. Folded mains cable fixed with strips of adhesive tape;
 4. Non-metallic table;
 5. Line Impedance Stabilization Network (LISN) with:
 - B - connection to reference ground.
 - P - jack for DUT.
 - M - coaxial connection to measuring receiver.
 6. RFI measuring receiver;
- All dimensions are given in centimeters.

When the measure is carried out on hand held equipment (e.g. portable drill), the operator's hand is simulated by means of a circuit, connected to the Artificial Hand plug on the front panel of PMM L2-16B LISN, consisting of a 200 pF capacitor connected in series with a 500 Ohm resistor. If the equipment case is metallic, simply connect plug with case of the DUT, otherwise wrap a metal foil around the DUT's handles. The foil are connected together and to the plug, as shown in the following figure:

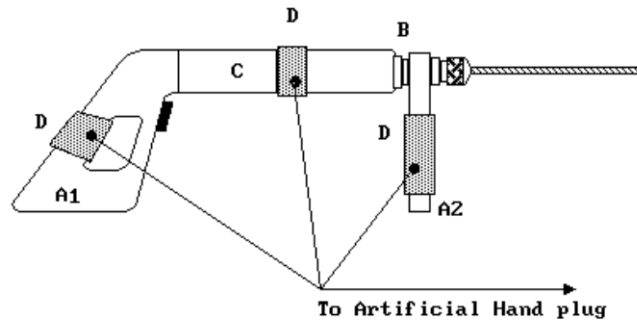
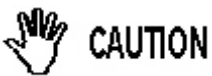

Fig. 5-2 Typical hand held equipment test set-up



CAUTION

Internal hardware checks and repairs shall be performed only by authorized assistance and service centers.

The manufacturer, the worldwide distributors and the national distributor agents shall not be responsible and kept liable for damages to goods, to instruments or persons caused during unauthorized operations on the instrument, or by manumitted instrument.

5-2 Network verification and maintenance

To verify proper operation of the PMM L2-16B Network use the following test procedure:



WARNING

Do not connect any AC or DC supply to PMM L2-16B Network during this verification test.

Test equipment needed:

1. RF Generator and level measuring calibrated instrument or
 2. Spectrum Analyzer with Tracking Generator.
- In both cases, instrument shall be working at 1 MHz.

Verification test procedure:

1. Connect the RF signal (or tracking signal) to the mains output of L2-16B making sure that the ground is connected to the shield of the RF cable (grounded). The RF signal (or tracking signal) shall be taken to L1 and L2 sockets, alternatively
2. Connect PMM L2-16B Network RF output 3 to the level-meter input (or Spectrum Analyzer input).
3. Attenuation between generated signal level and measured level on output shall be less than 0.5dB at 1 MHz. If higher than 0.5 dB, please refer to qualified NARDA Service Center for maintenance of the unit.

Caro cliente

grazie per aver acquistato un prodotto NARDA! Sei in possesso di uno strumento che per molti anni ti garantirà un'alta qualità di servizio. NARDA riconosce l'importanza del Cliente come ragione di esistenza; ciascun commento e suggerimento, sottoposto all'attenzione della nostra organizzazione, è tenuto in grande considerazione. La nostra qualità è alla ricerca del miglioramento continuo. Se uno dei Suoi strumenti NARDA necessita di riparazione o calibrazione, può aiutarci a servirla più efficacemente compilando questa scheda e accludendola all'apparecchio.

Tuttavia, anche questo prodotto diventerà obsoleto. In questo caso, ti ricordiamo che lo smaltimento dell'apparecchiatura deve essere fatto in conformità con i regolamenti locali. Questo prodotto è conforme alle direttive WEEE dell'Unione Europea (2002/96/EC) ed appartiene alla categoria 9 (strumenti di controllo). Lo smaltimento, in un ambiente adeguato, può avvenire anche attraverso la restituzione del prodotto alla NARDA senza sostenere alcuna spesa. Può ottenere ulteriori informazioni contattando i venditori NARDA o visitando il nostro sito Web www.narda-sts.it.

Dear Customer

thank you for purchasing a NARDA product! You now own a high-quality instrument that will give you many years of reliable service. NARDA recognizes the importance of the Customer as reason of existence; in this view, any comment and suggestion you would like to submit to the attention of our service organization is kept in great consideration. Moreover, we are continuously improving our quality, but we know this is a never ending process. We would be glad if our present efforts are pleasing you. Should one of your pieces of NARDA equipment need servicing you can help us serve you more effectively filling out this card and enclosing it with the product.

Nevertheless, even this product will eventually become obsolete. When that time comes, please remember that electronic equipment must be disposed of in accordance with local regulations. This product conforms to the WEEE Directive of the European Union (2002/96/EC) and belongs to Category 9 (Monitoring and Control Instruments). You can return the instrument to us free of charge for proper environment friendly disposal. You can obtain further information from your local NARDA Sales Partner or by visiting our website at www.narda-sts.it.

Servizio richiesto: *Service needed:*

Solo taratura Riparazione Riparazione & Taratura Taratura SIT Altro:
 Calibration only Repair Repair & Calibration Certified Calibration Other:

Ditta:

Company:

Indirizzo:

Address:

Persona da contattare:

Technical contact person:

Telefono:

Phone n.

Modello:

Equipment model:

Numero di serie:

Serial n.

Accessori ritornati con l'apparecchiatura: **Nessuno** **Cavo(i)** **Cavo di alimentazione** **Altro:**
 Accessories returned with unit: *None* *Cable(s)* *Power cable* *Other:*

Sintomi o problemi osservati: *Observed symptoms / problems:*

Guasto: **Fisso** **Intermittente** **Sensibile a:** **Freddo** **Caldo** **Vibrazioni** **Altro**
 Failure: *Continuous* *Intermittent* *Sensitive to:* *Cold* *Heat* *Vibration* *Other*

Descrizione del guasto/condizioni di funzionamento:

Failure symptoms/special control settings description:

Se l'unità è parte di un sistema descriverne la configurazione:

If unit is part of system please list other interconnected equipment and system set up:

