

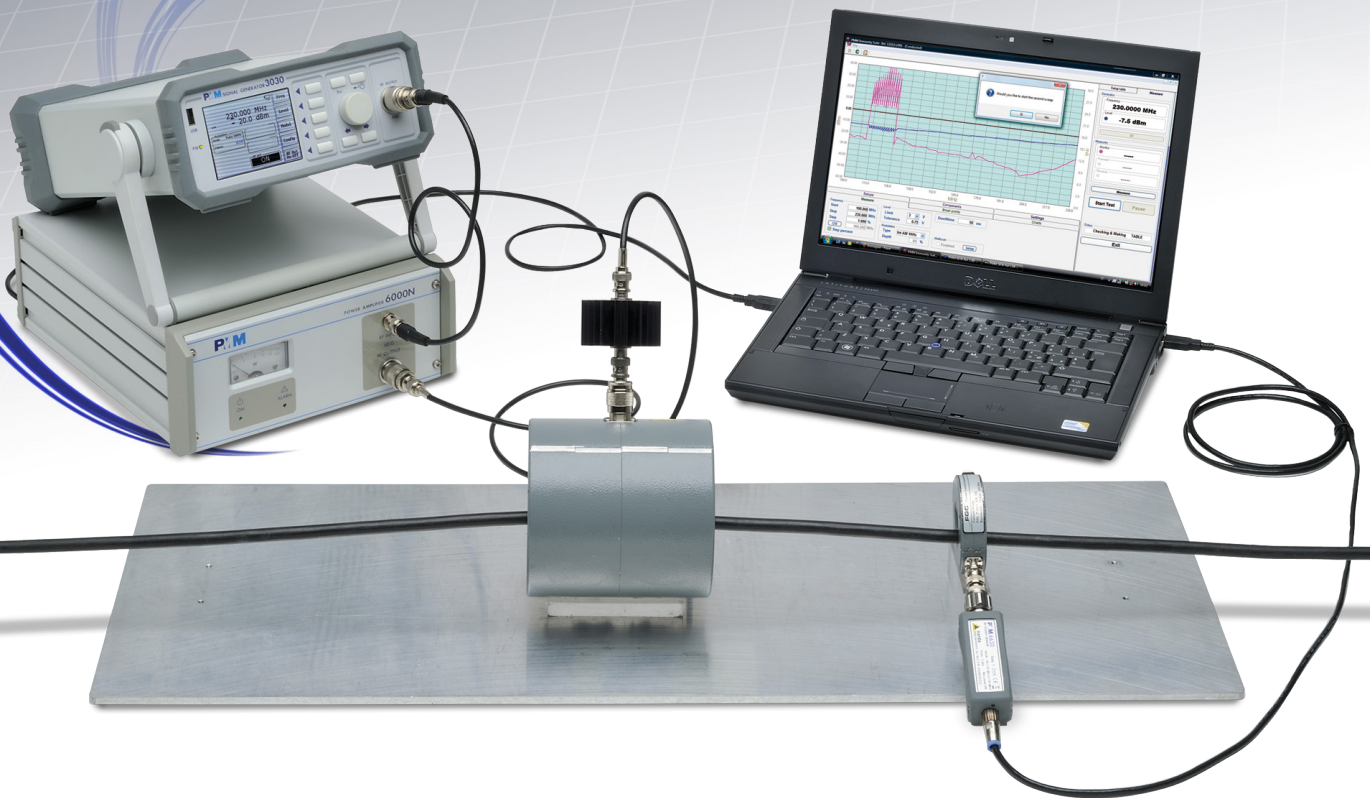

narda

Safety Test Solutions[®]

an  Communications Company



Cond-IS

RF Conducted Immunity System

About RF Conducted Immunity



In the global contest of EMC testing for residential and industrial EUTs (Equipments Under Test) "RF Conducted Immunity" compliance verification is definitely one of the easiest and less expensive to be performed "in house", not requiring any special environment and normally involving a low power RF Amplifier. For this reason NARDA Italy has renewed its already well known as 6000S/10 RF Immunity System with components and test management software to follow and even overcome latest requirements from the Standard IEC/EN 61000-4-6.

PMM Modularity

Continuing with the philosophy of a "Modular Approach", which still provides several advantages for actual use and future upgrades of the system when compared to "compact" solutions, main innovations are represented by the introduction of the new RF Generator 3010 and True RMS Power Meter 6630, both controllable through USB Ports by any PC. The power meter 6630 can be operated up to 3 GHz, so representing an ideal companion for Radiated Immunity applications as well, in particular when matched to the same frequency range provided by the RF Generator model 3030. Thanks to such modularity, the operator can always select the best suitable components for his applications, never losing the chance to modify or upgrade the system in future.



PIMS Software

The new "PMM Immunity Suite" software, accurately designed in terms of functions and user friendly approach, can manage the whole range of PMM components during both Test and Calibration processes, introducing the possibility of looking at the various monitoring tracks from generator and power meters (from field meter too in case of Radiated Immunity).



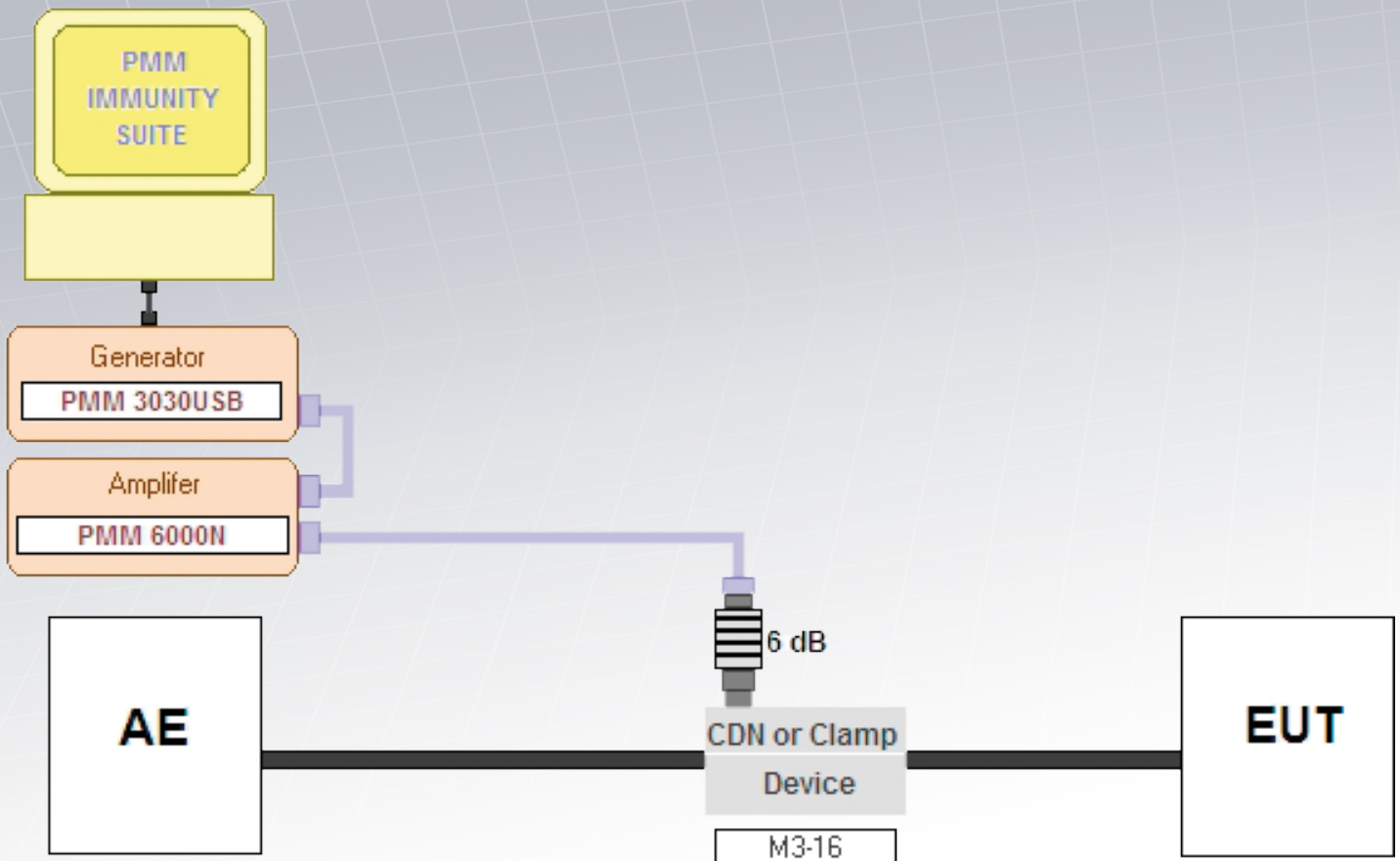

Cond-IS/10 System Composition

Cond-IS/10 system has been designed to provide all necessary components required for testing in accordance to IEC/EN 61000-4-6 with just one "package", not losing modularity but still maintaining a very simple and cost effective solution.

Operator can then only focus on testing, without worrying about collecting components and being sure they can properly work together automatically driven by a specifically designed software.

The Cond-IS/10 system includes following standard components:

- Generator 3010 , 9 kHz – 1 GHz, -107 to +10 dBm
- Amplifier 6000N, 9 kHz – 230 MHz, 10/15 W
- ATT-25W, 6 dB Attenuator, 25 W max
- CDN M3-16, 3 lines 16 A each, calibrated at 1, 3 and 10 V levels
- Cab-06, Cable Kit to fully connect the system
- PIMS, PMM Immunity Suite software for Windows™ OS operated PCs.

In case any different testing device should be required, it would

always be possible to customize the system accordingly.

More powerful amplifiers are also available upon request when a "Special" Test Level over 10 V should be achieved or when using an EM Clamp in conjunction with a Filtering Clamp; in this case the 6 dB Attenuator should be changed as well, according to the new max power level.

As additional benefit, NARDA Italy Labs always provide the selected device (CDN, EM Clamp or Current Injection Probe) fully calibrated at 1, 3 and 10 V standard stress levels, together with the whole Cond-IS/10 system, i.e. including all RF cables and components belonging to the real testing condition.

CDNs, EM Clamps and Current Injection Clamps Calibration according IEC/EN 61000-4-6

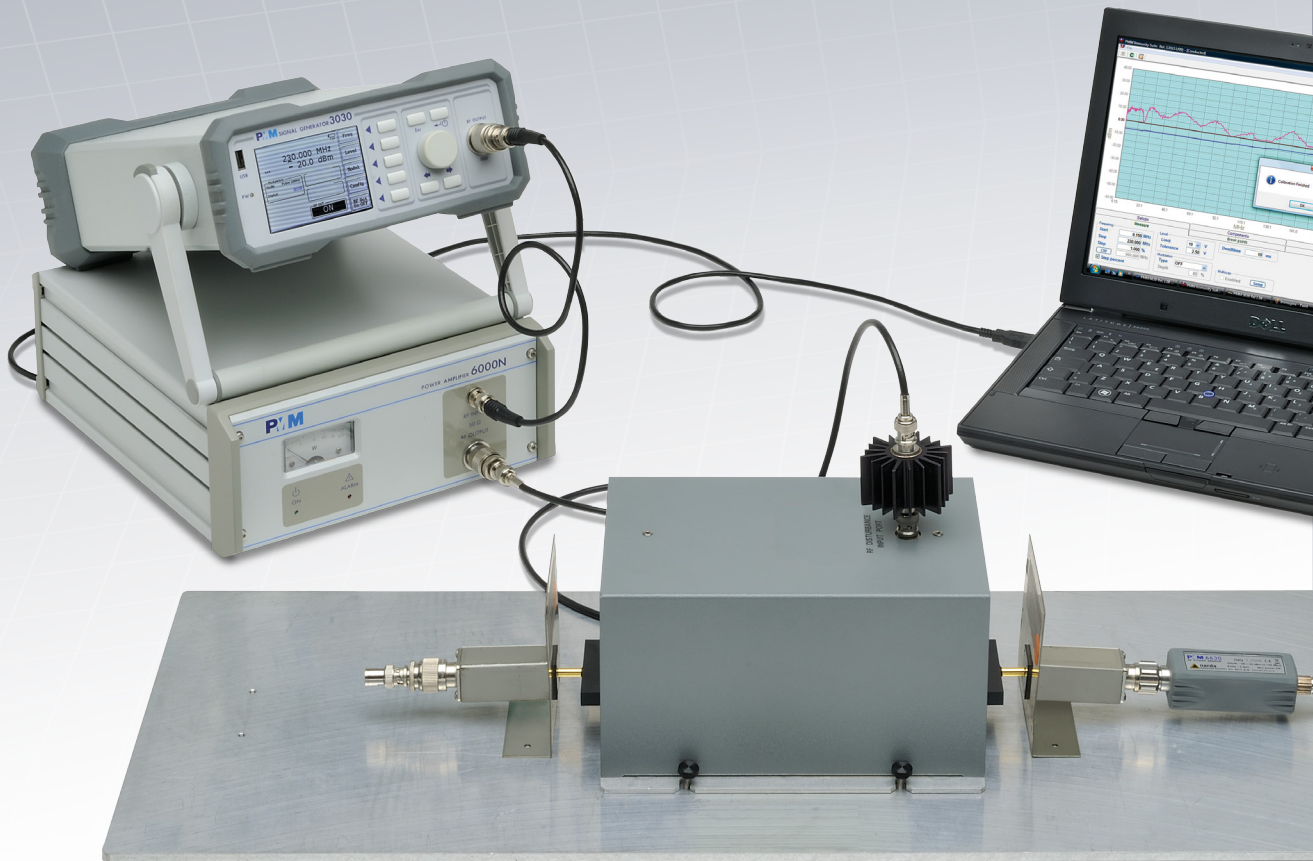

The EMC Standard IEC/EN 61000-4-6 requires usage of CDNs for power and signal lines whenever applicable, what is always assuring a proper "coupling" of RF stress signal in the direction of the EUT and a "decoupling" toward the Auxiliary Equipment (AE) on the other side.

The 150 Ω common-mode matching impedance on both sides is required to provide the highest possible reproducibility of the test in every other laboratory worldwide.

To reach the standard Test Levels of 1, 3 and 10 V each CDN must be calibrated at first for each of these levels to get proper stress signal during real EUT testing phase. When CDNs are not suitable for some special signal cables or multi-wires connections in general, devices like EM Clamps or Current Injection Clamps must be used.

In case of EM Clamps, providing a combined capacitive and inductive coupling of the RF stress signal, the Calibration Set-Up is almost identical to that for CDNs, just inserting the EM Clamp between the two 50-150 Ω Adapters interconnected by a properly diameter sized wire.

Calibration Tables are normally provided with the Cond-IS/10 system but could also be generated on site when purchasing a 6630 Power Meter and necessary Calibration Kits for each selected coupling/decoupling device.

As calibration accuracy depends on all components used in the test set-up, every time a device should be re-calibrated the whole system (including Generator, Amplifier, Attenuator and RF Cables) would have to be sent back to the calibration laboratory, that's why in most cases the addition of the

CDN Calibration Set-Up according to the Standard requires some additional components which are no more required during the Test, as for the following list:

- Shorting Adapters (no. 2 pieces for each CDN)
- 50-150 Ω Squares Adapters (100 embedded impedance, no. 2 pieces for each CDN)
- 50 Ω Termination (mounted on a N-BNC Adapter)
- RF Power Meter.



CDN Calibration Kit



EM Clamp

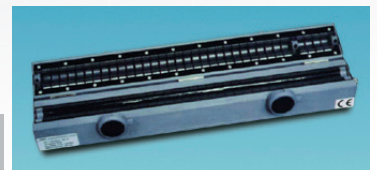

Current Injection Clamp

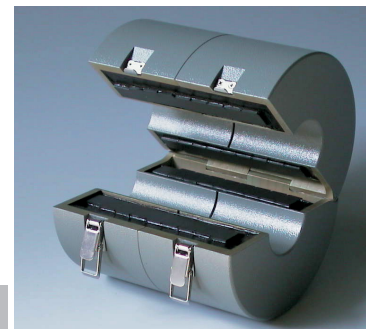

6630 and Calibration Kit would provide the best solution for performing calibration on site and faster as well.

The whole Calibration Procedure is automatically managed by PIMS software, then operator will simply have to define Device and Test Level before starting it; on-going monitoring will be always available through live diagrams showing Generator RF Output Power and Power Meter measured levels step by step.

Current Injection Clamps (inductive coupling) require a specific "Calibration Jig" instead, whose mechanical dimensions and manufacturing details are clearly defined in the Standard.

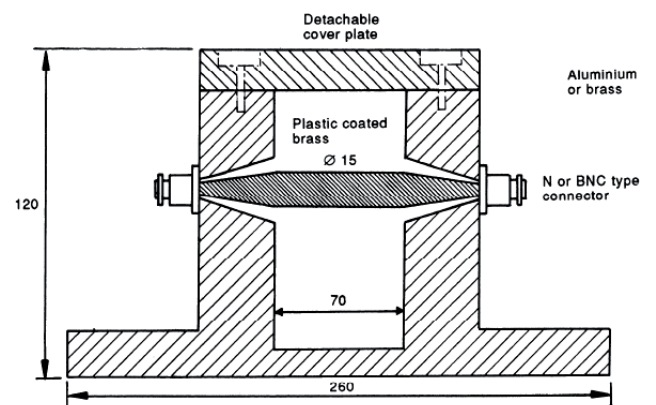

Jig width = 120

Current Clamp calibration fixture

Current Injection Clamp and Monitoring Probe according IEC/EN 61000-4-6

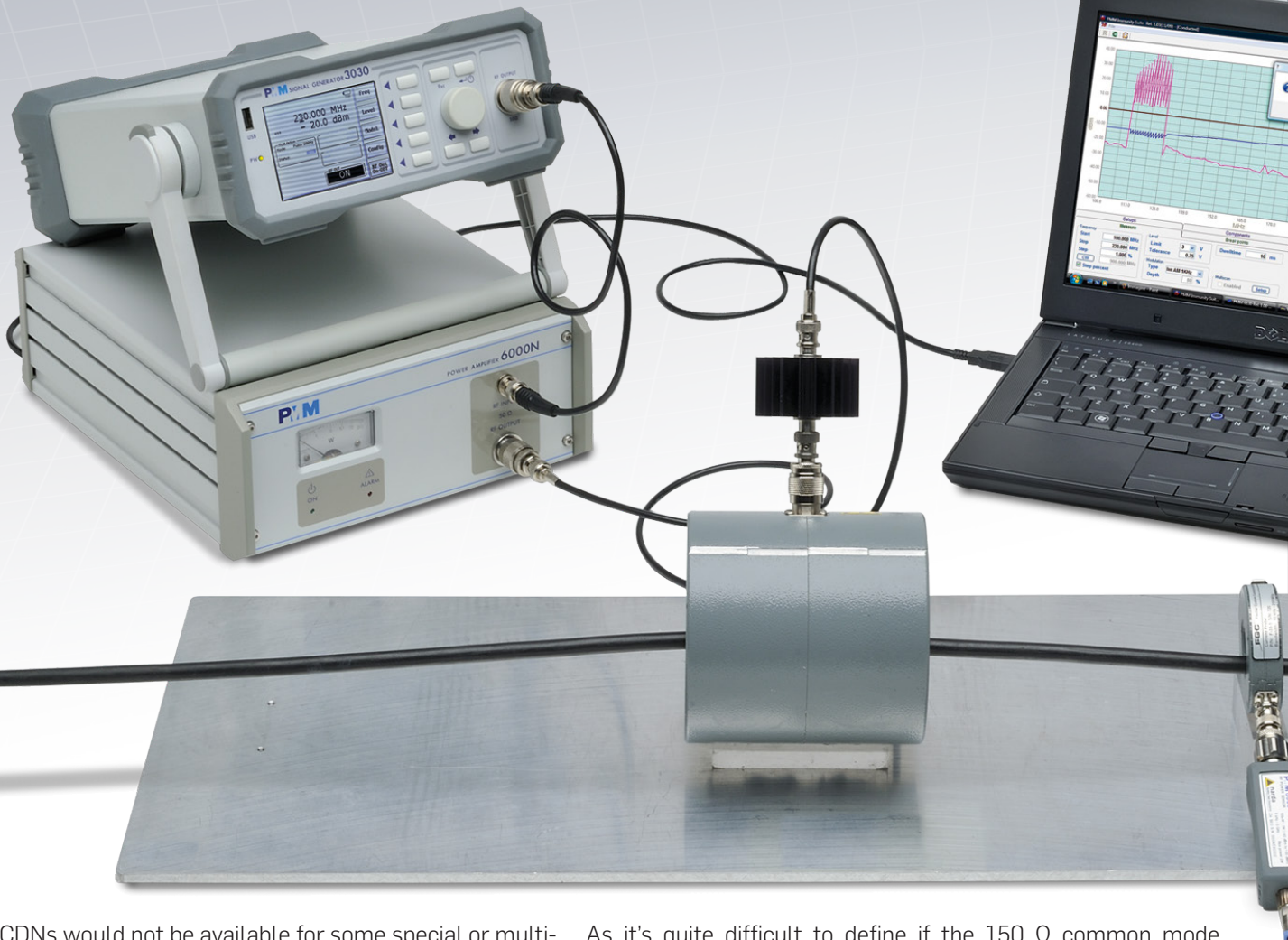

In case CDNs would not be available for some special or multi-wires cables' connection between EUT and AE, the Standard allows testing with a different method, i.e. using Current Injection Clamp & Monitoring Probe. This method is much more effective if compared to the other one using the EM Clamp, due to a less expensive configuration in terms of device used to properly inject RF stress signal and power required from amplifier.

A clear flow chart is provided in the Standard to help operators in defining when a Clamp has to be used for such Conducted Immunity Test.

Two different set-ups are defined depending mainly on the 150Ω impedance matching condition at AE side, what could require or not a monitoring of the injected current at EUT side (subclauses 7.3 and 7.4 in the Standard).

As it's quite difficult to define if the 150 Ω common mode impedance matching will be achieved or not for each specific EUT/AE combination, it appears more convenient to apply subclause 7.4 using a Current Monitoring Probe together with a Current Injection Clamp, what PMM has always recommended since several years ago.

No additional filtering devices are required to assure the 150 Ω impedance matching, while the injected current is always monitored to not trespass the threshold level of $U_0/150$, where U_0 is the voltage test level required for that specific EUT.

A 30W amplifier is normally enough to drive such a test up to the 10V level.

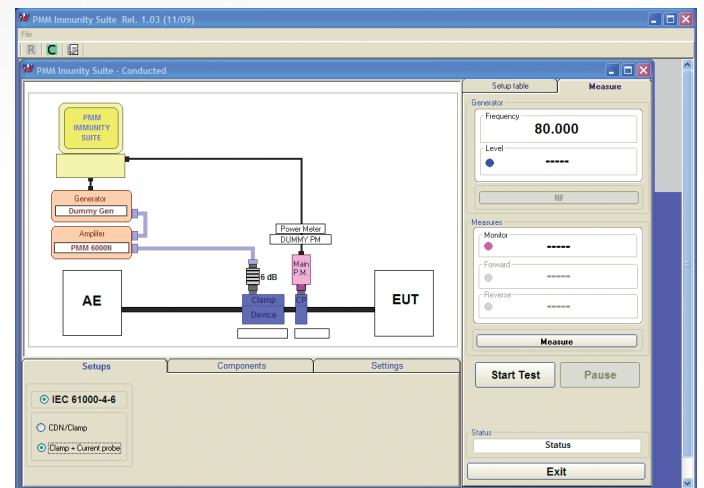
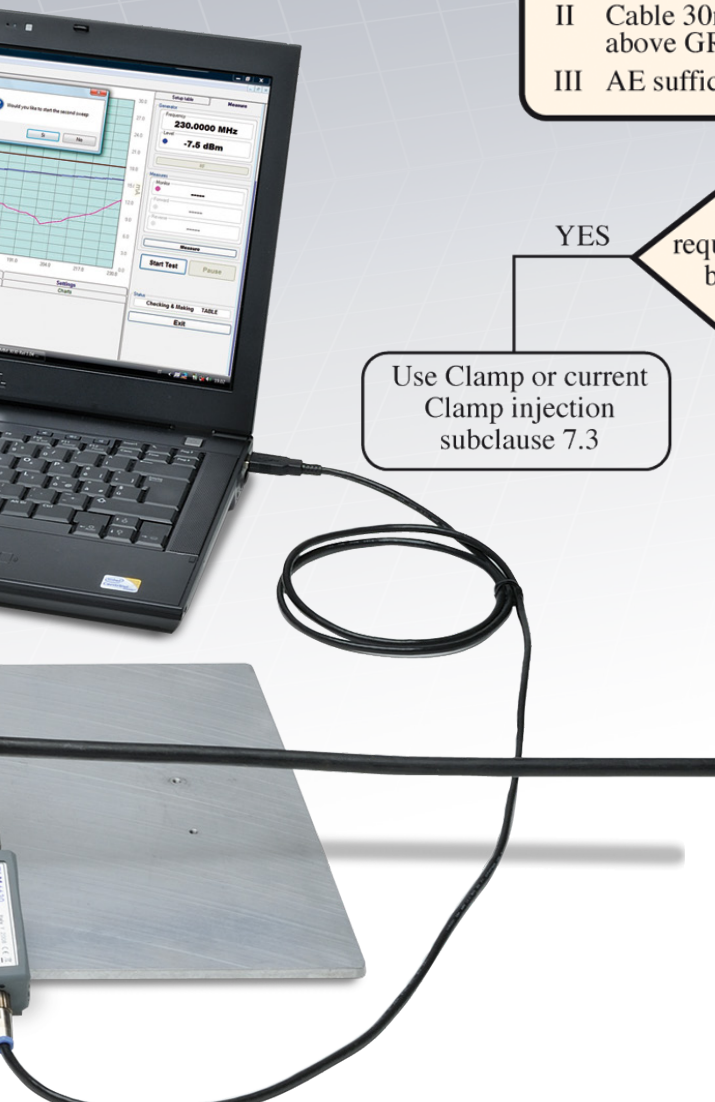
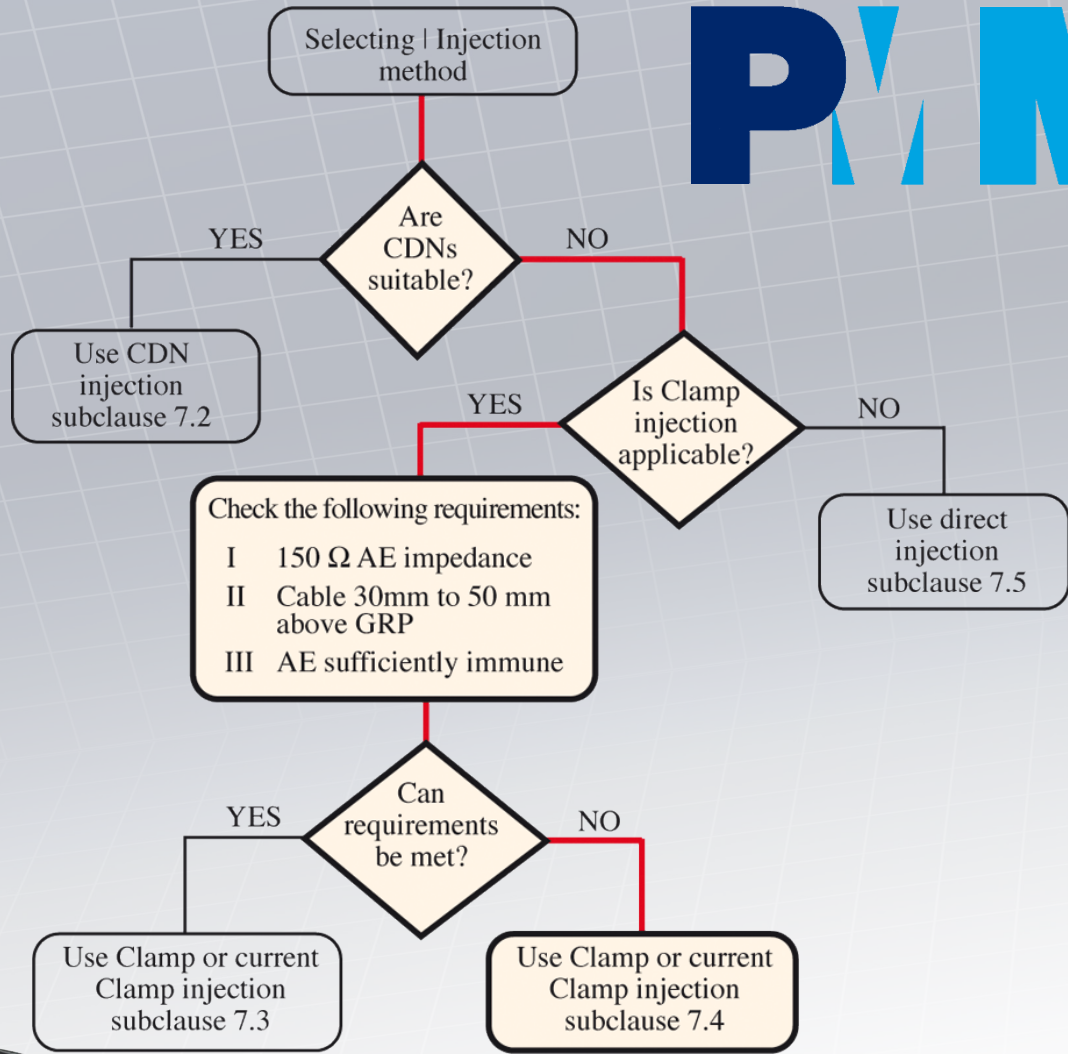

The test is then performed in 2 different steps:

- verification of Threshold Current Value and modification of RF Generator output levels accordingly, without AM modulation super-imposition
- use of the modified Generator Table (frequency vs. level) to perform the test with the addition of AM modulation.

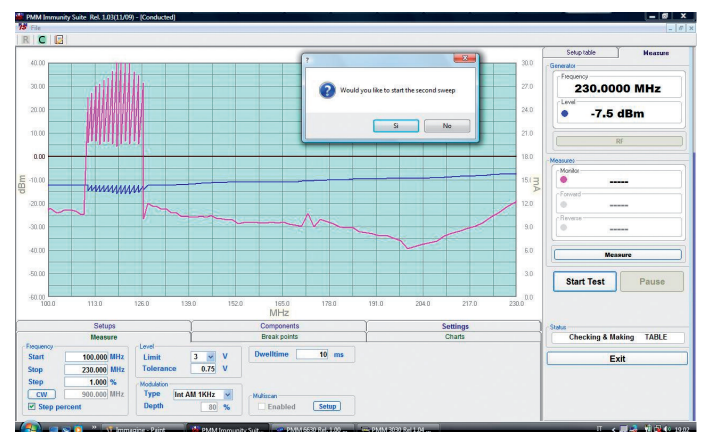

“PMM Immunity Suite” Software

Same PIMS suite is also designed for driving Radiated Immunity Tests according to IEC/EN 61000-4-3 in both Semi-Anechoic Chambers or TEM/GTEM Cells, including calibration of radiated field up to 16 points in a grid of Field Uniformity assurance, but this is just for general info, as beyond the scope of present leaflet. So please refer to specific separate documentation for further details.

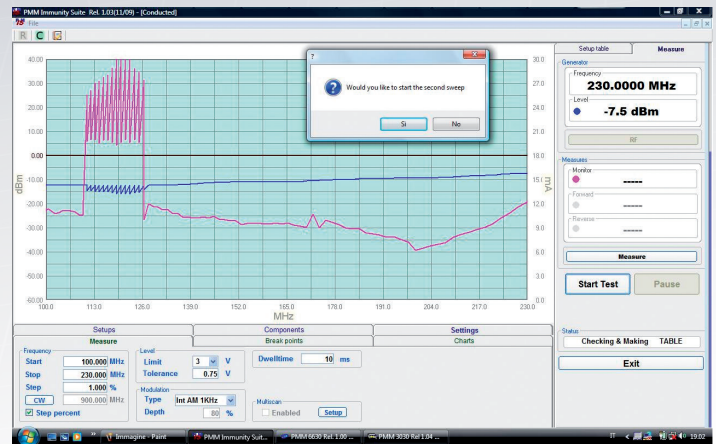
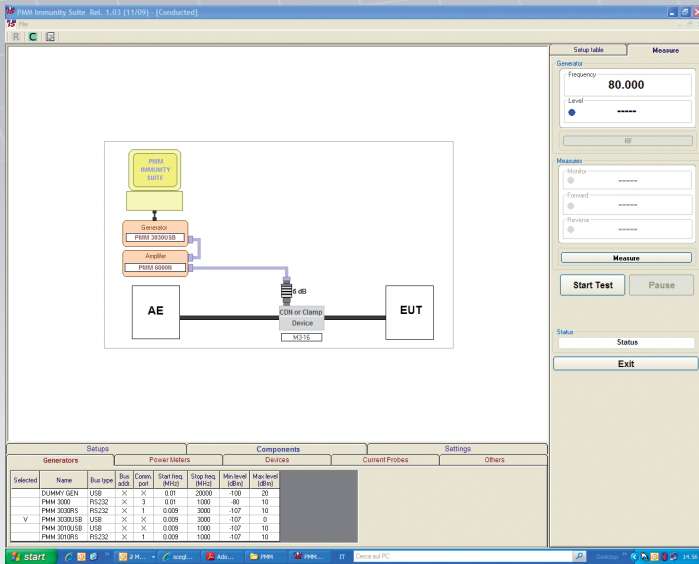

Graphical traces provide real time monitoring of Generator Output and Power Meter readings

PMM has developed a suite of utilities specifically designed for EMC Immunity applications, capable of driving all necessary operations for both Calibration and Testing with several devices (CDNs, EM Clamps, Current Injection Clamps and others used for Radiated Immunity as well) .

The software is user friendly and provides a really ergonomic configuration which comfortably drives the operator through the various steps, from definition and selection of HW components to settings of required parameters and finally starting the test with “just one button”.

Program window has been designed for omnicomprehensive overview of each specific test being performed, so that operator can easily control all details with a quick glance.

A graphical scheme of the test set-up clearly reminds about proper physical connections between components, which could slightly differ between Tests and Devices' Calibration.

In the right portion of the screen two different tags allow simple selection of Table Creation (i.e. calibration) or Test Execution, providing all details about Generator and Power Meter status.

At window's bottom some other tags provide intuitive subsequent steps for setting about various Setups, system Components and Testing parameters.

On top of everything, testing and calibration procedures are always updated to state of the art requirements of reference Standards.

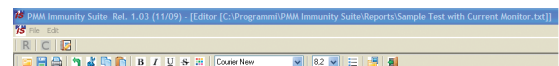

```

PMM Immunity Suite - Rel. 1.03 [11/09] - [Editor [C:\Programmi\PMM Immunity Suite\Reports\Sample Test with Current Monitor.txt]]
File: txt
EM 61000-04-06 - P M M Immunity Suite
Date: 01/09/2010
Time: 19.01.26
Company name: NARDA Italy
E.O.T. name: Single Cable
E.O.T. S/N: xxxxyy
Operator: ME

Test equipment:
Generator: Narda-BTS PMM 30000B
Power Meter: Narda-BTS PMM 6500
Device: FCC P1210-0A
Current Probe: Typical TYPICAL

Ambient data:
Temperature: 21
Humidity: 50%
Atm. pressure: 1000mb

Note: Sample Test with Current Injection Clamp and Monitoring Probe for a Test Level of 3V

Test settings:
Start Frequency: 100 MHz
Stop Frequency: 230 MHz
Step Frequency: 1 MHz
Modulation type: Int AM 10%
Modulation depth: 80 %
Sweep: 30
Tolerance: 0.75V
Dwell time: 0.25 s
Calibration Table name: tabc_3
* R.B.: The first sweep is done without modulation.

Modified table after first sweep: tabc_3_after adjustment

Event Log n°1 - Time: 19.05.12 - Elapsed time: 00:13:49
Generator Frequency: 124.1487 MHz
Generator Level: -12.1 dBm
Note: 3rd SWEEP Sample on case of EUT Failure

Event Log n°2 - Time: 19.06.37 - Elapsed time: 00:14:14
Generator Frequency: 177.2107 MHz
Generator Level: -10.0 dBm
Note: 2nd Sample of Malfunction at EUT detected and recorded while passing

Event Log n°3 - Time: 19.08.28 - Elapsed time: 00:17:04
Generator Frequency: 226.7926 MHz
Generator Level: -8.0 dBm
Note: 3rd SWEEP for Failure Sample
    
```

A complete Report is automatically generated during the test, including information about Company, Operator, EUT and Environmental Conditions, as well as all details of settings used for the scan and Event Logs at time of failures identified by the operator.

Several auxiliary functions for Debugging are also available

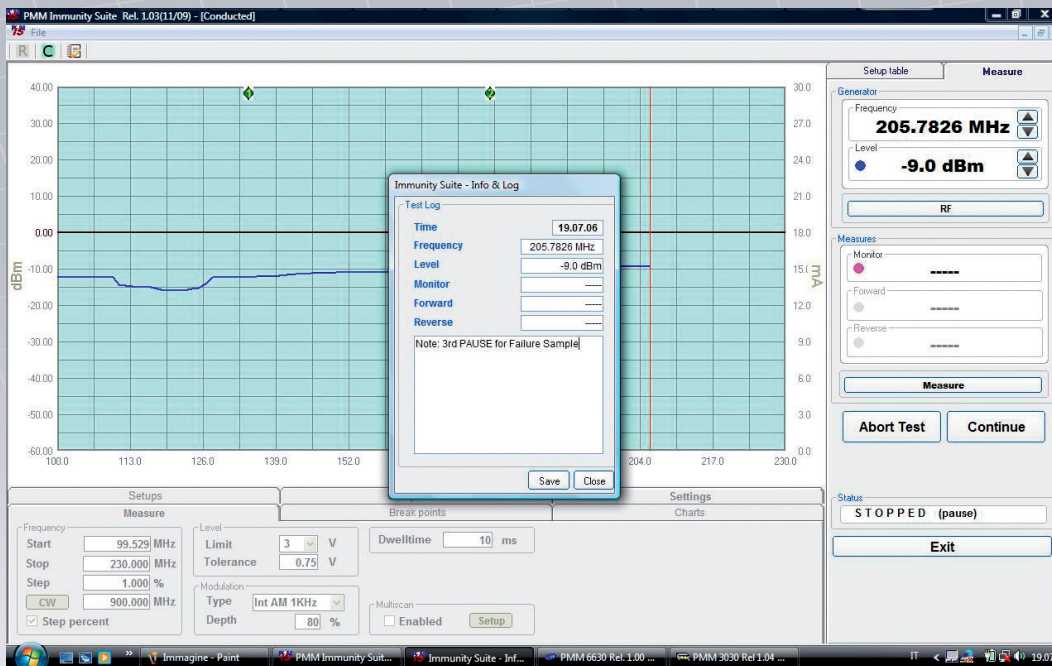

Pause during the frequency scan at EUT failures and Manual Adjustment of both Frequency and Level to identify threshold of susceptibility.

Setups		Components		Settings	
Measure		Break points		Charts	
	Freq. MHz	Comment			
Stop 1			
Stop 2			
Stop 3			
Stop 4			
Stop 5			

Break Points definition to momentarily stop the test at some frequencies for any reason.

P M M MULTISCAN Setup							
MultiScan Options							
Start	Stop	Step	Dwell	Modulation	Depth	Table Name	Level
MHz	MHz	%	mSec		%		V/m
0.15	0.3	1.0	1000	Int (1 KHz)	80	tabclamp_3	3
1.2	15.5	1.0	1000	Int (1 KHz)	80	tabclamp_3	3
157.0	230.0	1.0	1000	Int (1 KHz)	80	tabclamp_3	3

Multi-Scan Table to perform test only on most critical frequency's segments and save time during debugging phase.

Freq.(MHz)	Level (dBm)
0.1500	✓ -13.0
0.1515	● -12.8
0.1530	● -12.5
0.1545	● -12.3
0.1561	● -12.1
0.1577	● -11.8
0.1592	● -11.6
0.1608	● -11.4
0.1624	● -11.1
0.1641	● -10.9
0.1657	● -10.6
0.1674	● -10.4
0.1690	● -10.2
0.1707	● -9.9
0.1724	● -9.7
0.1741	● -9.5
0.1759	● -9.2
0.1776	✓ -9.0
0.1794	● ----
0.1812	● ----

Automatic Fill-Up Table by linear interpolation between arbitrary Generator Output Levels defined by the operator to generate "custom stress profiles".

Technical Specifications



EMC RF Generator 3010 and 3030

	3010	3030
Frequency range	9 kHz - 1 GHz	9 kHz - 3 GHz
Frequency resolution	1 kHz	1 kHz
Frequency accuracy (internal reference)	± 10 ppm @ f>10 MHz	± 10 ppm @ f>10 MHz
Level Range	-107 to +10 dBm	-107 to +10 dBm
Level resolution	0.1 dB	0.1 dB
Level accuracy	± 1 dB, level > -30 dBm	± 1 dB, level > -30 dBm
Output impedance	50 Ω	50 Ω
RF output connector	Type N female	Type N female
Spectral purity-harmonic	< -30dBc @ 0 dBm, f > 1 MHz	< -30dBc @ 0 dBm, f > 1 MHz
AM modulation, internal	2 Hz - 50 Hz - 400 Hz, 1 kHz; 10% to 90%	2 Hz - 50 Hz - 400 Hz, 1 kHz; 10% to 90%
AM modulation, external	2 Hz to 10 kHz; 10% to 90%	2 Hz to 10 kHz; 10% to 90%
Input impedance	600 Ω	600 Ω
Input connector	BNC female	BNC female
Internal pulse modulation	1 Hz; On/Off ratio @ 0 dBm > 40 dB 200 Hz; On/Off ratio @ 0 dBm > 40 dB 100 Hz 1:2; On/Off ratio @ 0 dBm > 40 dB 100 Hz 1:24; On/Off ratio @ 0 dBm > 40 dB 200 Hz 1:8; On/Off ratio @ 0 dBm > 40 dB 217 Hz 1:8; On/Off ratio @ 0 dBm > 40 dB 1 kHz 1:2; On/Off ratio @ 0 dBm > 40 dB	1 Hz; On/Off ratio @ 0 dBm > 40 dB 200 Hz; On/Off ratio @ 0 dBm > 40 dB 100 Hz 1:2; On/Off ratio @ 0 dBm > 40 dB 100 Hz 1:24; On/Off ratio @ 0 dBm > 40 dB 200 Hz 1:8; On/Off ratio @ 0 dBm > 40 dB 217 Hz 1:8; On/Off ratio @ 0 dBm > 40 dB 1 kHz 1:2; On/Off ratio @ 0 dBm > 40 dB
Remote control	RS232, USB 2.0 (rear), User port GPIB (external adapter)	RS232, USB 2.0 (rear), User port GPIB (external adapter)
User port	RF On/OFF, Start/Stop test	RF On/OFF, Start/Stop test
Display units	dBm, dBμV	
Operating temperature	10° to 40°C	10° to 40°C
Power Supply	10 - 15 Volt DC, 2.5A; AC/DC adapter 115/230 V 50/60 Hz	10 - 15 Volt DC, 2.5A; Li-Ion interchangeable battery (4 h operations, average); AC universal adapter/charger
Plug-in battery pack (model 3030-02)	-	Li-Ion, rechargeable 3 hours average operation time
Dimensions	235 x 105 x 335 mm (WxHxD)	235 x 105 x 335 mm (WxHxD)
Weight	3.5 kg	3.5 kg (mod. 3030-01) 4.3 kg (mod. 3030-02)

Amplifier 6000N

Frequency range	9 kHz - 230 MHz
Power output	10 W; 15 W from 150 kHz - 80 MHz
Compression	< 1 dB
Harmonic distortion	< -25 dB
Input for max output	1 mV
Input connector	BNC
Output impedance	50 Ω
Output connector	Type N female
Power indication	Analog meter, 20 W f.s.
Power	84 - 264 VAC, 60 W, 47 - 440 Hz
Size	257 x 110 x 315 mm (WxHxD)
Weight	4 kg

PIM



USB RF Power Sensor 6630

Frequency range	9 kHz - 3 GHz
Power measurement range	100 nW to 1 W -40 to +30 dBm
Max input power	2 W peak envelope max. 300 ms
Power linearity	0.2 dB (-40 to +30 dBm @ 50 MHz; 25 °C ± 10 °C)
Measurement accuracy ^{1, 2, 3}	< 0.35 dB
Measurement path	High: +30 to -9 dBm Low: -9 to -40 dBm 1 dBtyp. switching point hysteresis
Max SWR	1.10 10 ÷ 300 kHz, +30 ÷ -9 dBm 1.05 >300 kHz ÷ -9 dBm 1.10 >100 MHz ÷ 1 GHz 1.25 >1 GHz ÷ -3 GHz 1.20 10 kHz ÷ 3 GHz, -9 ÷ -40 dBm
Operating temperature	-10°C ÷ +50°C
Power supply	5 VDC - 100 mA from USB port
RF connector	N male, 50 Ω
PC communication interface	USB 1.0 - 1.1 - 2.0
PC software	WIN6630 utility (supplied)
PC software settings	N° of Averages /1 to 1024) Offset Correction factor
Measuring units	dBm, dBμV, W, Vrms
Dimensions	30 x 30 x 95 mm (WxHxD)
Weight	0.12 kg

1. Max. SWR of source: 1.25

2. Calculated with worst calibration uncertainties to the calibration factor of 0.17 dB

3. At set frequency

Ordering Information Conducted Immunity System

Cond-IS/10	Conducted Immunity System from 10 kHz up to 230 MHz Composed by: 3010 + 6000N + M3-16+Att-25W+PIMS software + Cab-06 (cable kit) + calibration curves for 1, 3, 10V stress levels
------------	--

Components available separately

3010	Signal generator 9 kHz - 1 GHz, AC power
3030-01	Signal generator 9 kHz - 3 GHz, AC power
3030-02	Signal generator 9 kHz - 3 GHz, AC power, Li-Ion internal rechargeable battery
6000N	10/15W RF Linear Amplifier 9 kHz - 230 MHz
6630	USB RF Power sensor 9 kHz - 3 GHz
6630 FOA	Adapter for RF Power meter; fiber optic to USB connection (10 m). Internal rechargeable battery.
PIMS	PMM Immunity Software for IEC/EN 6100-4-6 / 6100-4-3 (Available for free on our website)

Additional component

F-2031-23	Injection clamp (23mm aperture)	F-120-9A	Injection probe
F-2031-23 mm	2x 150-50 Ω adapters and 50 Ω load for F-2031-23	BCICF-4	Complete calibration kit for F-120-9A
F-2031-23-DCN	Decoupling Network (23 mm aperture)	F-33-1	Current monitor

CDN for mains

M1-16	CDN for mains (1 line 16A). Shorting adapter not required	M1-32	CDN for mains (1 line 32A). Shorting adapter not required
M2-16	CDN for mains (2 line 16A).	M2-16-SA	Set of shorting adapter
M2-32	CDN for mains (2 line 32A)	M2-32 SA	Set of shorting adapter
M3-16	CDN for mains (3 line 16A)	M3-16-SA	Set of shorting adapter
M3-32	CDN for mains (3 line 32A)	M3-32-SA	Set of shorting adapter
M4-32	CDN for mains (4 line 32A)	M4-32-SA	Set of shorting adapter
MX-XX	CDN for mains (2 line 16A)		

Unshielded, unbalanced lines CDNs

AF-2	2 lines CDN	AF-2-SA	Set of shorting adapter
AF-4	4 lines CDN	AF-4-SA	Set of shorting adapter

Shielded Lines CDNs

S2	2 lines CDN	S2-SA	Set of shorting adapter
S9	9 lines CDN	S9-SA	Set of shorting adapter

Balanced lines CDNs

T2	2 lines CDN	T2-SA	Set of shorting adapter
T4	4 lines CDN	T4-SA	Set of shorting adapter

6 dB Attenuators

ATT-25W	6 dB, 25W attenuator	ATT-75W	6 dB, 75W attenuator
---------	----------------------	---------	----------------------

Calibration kit and accessories

150-50-CDN	2x 150-50 Ω adapters and 50 Ω load	Load-50	50 Ω load with BNC connector
027.100.019	N-F / BNC-M adapter	CAB - BNC	BNC-BNC cable, 2 m length